

12.5 LITERS MANUAL/PNEUMATIC FLUID REFILLING SET

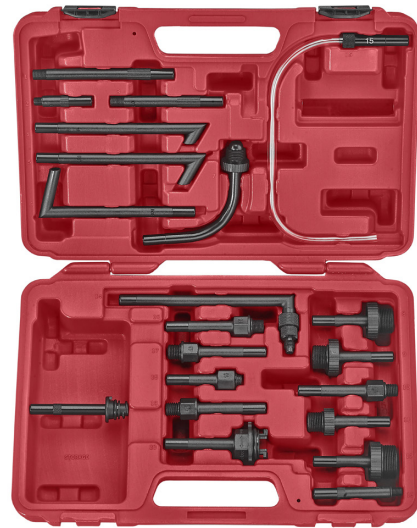

CE



PATENTED

1. FEATURES

2. SPECIFICATIONS

3. INSTRUCTIONS

4. APPLICATIONS

1. FEATURES

- Set for refilling fluids such as ATF, gear oil and differential oil
- Especially designed for vehicles without a transmission dipstick
- A combination of pneumatic and manual functions allow energy-saving work and precise refilling
- 12.5L large tank suitable for transmissions that require large refill volume

2. SPECIFICATIONS

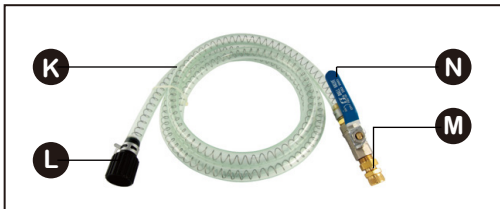
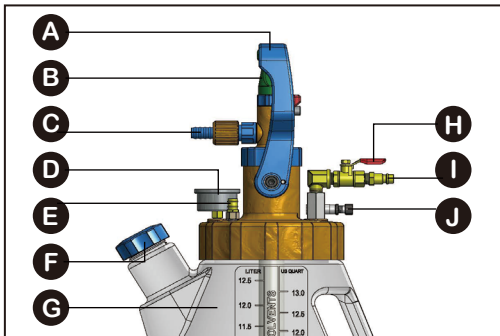

A	Square handle	Pull backward to release pressure
B	Manual pumping handle	One stroke about 0.1 liter
C	Connector to hose	Male M20 × 2.0
D	Pressure gauge	0-35 psi / 0-2.5 kg/cm ²
E	Auto pressure release	Preset at 14.2 psi / 1.0 kg/cm ²
F	Fluid refill cap	Open for refilling new fluid
G	Tank	12.5 liter / 3.3 US Quart
H	Shop air switch	Control compressed air
I	Shop air connector	Standard shop air connector
J	Pressure regulator	7-28.5 psi / 0.5-2.0 kg/cm ²
K	Wire reinforced hose	2 m / 78.7" in length
L	Connector to tank	Female M20 × 2.0
M	Connector to adapter	Female Ø9.5mm
N	Hose switch	Open for introducing new fluid

21 types of adapters for most common vehicles on the market.

Material: nylon 6-6



	Size	Application		Size	Application
1	1/8"-27NPT	Ford	12	M30 × 1.5	VAG 6-speed A/T
2	5/16"-24UNF	Volvo	13	M8 × 1.0	Nissan, Infiniti
3	M10 × 1.0	Volkswagen 6-speed	14	M10 × 1.0	VW 6-speed A/T
4	Hook type – S	VAG	15	Flexible 300mm hose	Honda, Hyundai
5	Hook type – M	VAG	16	M12 × 1.25	Nissan
6	Hook type – L	BMW, Honda, Nissan	17	M14 × 1.5	Mini Cooper
7	M18 × 1.5	Toyota	18	M10 × 1.5	Nissan
8	M24 × 1.5	VAG with DSG	19	M12 × 1.75	Cadillac, Chevrolet
9	M22 × 1.5	Audi with CVT	20	Ear clip type	Mercedes 725.0
10	M12 × 1.5	Mercedes 722.9	21	Twist type	Audi 7-speed dual-clutch
11	M18 × 1.5	Skoda, Volkswagen			

3. INSTRUCTIONS



CAUTION



- Always read carefully the instructions before working
- This tool set is for refilling ATF, gear oil and differential oil ONLY
- DO NOT use this tool for refilling other types of oil or fluid
- Always ensure pressure is adequately released after work
- Ensure the working area has adequate lighting
- Keep children and unauthorized persons away from the working area
- Keep working area clean and tidy, dry and free from unrelated materials
- DO NOT allow untrained persons to use this tool kit
- Always wear eye protection that meets OSHA and ANSI Z87.1 standards
- Always wear hand gloves when work with the tool
- Always wear ear protection
- Disposal: Customers should follow local regulations to handle used/waste fluids

INSTALLATION

- 1 Open *fluid refill cap* (F) and refill ATF, gear oil or differential oil to required volume. Refer to auto manufacturer's service manual for adequate volume.
- 2 Remove drain plug on transmission, gearbox or differential to drain fluids inside, and screw back drain plug after draining.
- 3 Choose a suitable refill adapter, and connect the adapter to *connector to adapter* (M) (Fig. 1).
- 4 Connect hose and tank together (Connect L to C) (Fig. 2).
- 5 Connect refill adapter to filling hole on transmission, gearbox or differential (Fig. 3).

OPERATION

- 1 Connect *shop air connector* (I) to shop air.
- 2 Turn on *shop air switch* (H).
- 3 Turn on *hose switch* (N), the fluid will be introduced to transmission, gearbox or differential.
- 4 Before all fluid is almost introduced, turn off the *hose switch* (N) and *shop air switch* (H).
- 5 Pull *square handle* (A) backward, and the pressure inside the tank will be released (Fig. 4).
- 6 Lift up *manual pumping handle* (B) (Fig. 5), and start pumping fluid manually till the transmission, gearbox or differential is filled with adequate volume.

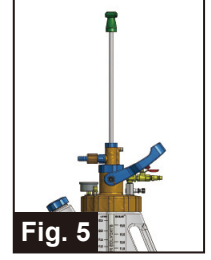
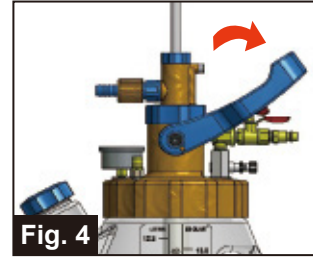
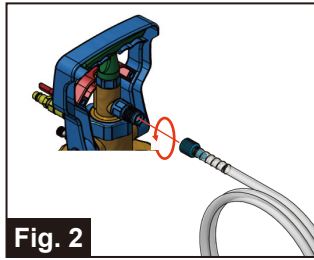
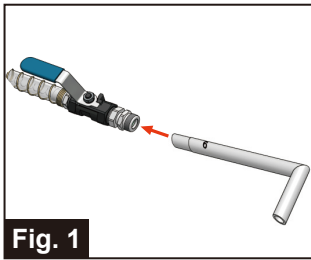

4. APPLICATIONS

The application list is for reference only. More vehicle applications are possible. Same vehicle models, due to variations in engine size, vehicle type (hatchback, sedan, or convertible...etc), engine fuel type (gasoline or diesel) and so on, may apply to different radiator test caps.

Make	Model	Year	Type	No.
Audi	A3	2005-2009	3.2L Quattro. 6-speed dual clutch	8
Audi	A3	2005-2023	2.0L. 6-speed dual clutch	8
Audi	A3	2009-2018	1.8L. 6-speed dual clutch	8
Audi	A3	2009-2023	2.0L Quattro. 6-speed dual clutch	8
Audi	A3	2015-2020	1.4L. 6-speed dual clutch	8
Audi	A4	2002-2005	1.8L, 3.0L. 6-speed AT	12
Audi	A4	2002-2005	1.8L, 3.0L. CVT Transmission	9
Audi	A4	2002-2005	Quattro 1.8L, 3.0L. 6-speed AT	12
Audi	A4	2005-2008	2.0L, 3.2L. 6-speed AT	12
Audi	A4	2005-2008	2.0L, 3.2L. CVT Transmission	9
Audi	A4	2005-2009	Quattro 2.0L, 3.2L. 6-speed AT	12
Audi	A4	2015-2023	1.4L, 2.0L; 2.0 TDI, 3.0 TDI. 7-Speed AT	21
Audi	A5	2010-2014	2.0L. CVT Transmission	9
Audi	A5	2016-2023	1.4L, 2.0L; 2.0 TDI, 3.0 TDI. 7-Speed AT	21
Audi	A5	2010-2017	2.0L Quattro. CVT Transmission	9
Audi	A6	1998-2001	2.8L. 6-speed AT	12
Audi	A6	2000-2004	Quattro 2.7L. 6-speed AT	12
Audi	A6	2000-2011	Quattro 4.2L, except 2009. 6-speed AT	12
Audi	A6	2002-2004	Quattro 3.0L. 6-speed AT	12
Audi	A6	2005-2008	Quattro 3.2L. 6-speed AT	12
Audi	A6	2006-2009	2.0L Quattro. CVT Transmission	9
Audi	A6	2009-2011	Quattro 3.0L. 6-speed AT	12
Audi	A6	2010-2018	2.0L; 3.0 TDI. 7-Speed AT	21
Audi	A6	2011-2018	1.8L, 3.0L; 2.0 TDI. 7-Speed AT	21
Audi	A6	2012-2018	2.0L. CVT Transmission	9
Audi	A6	2012-2018	3.0L Quattro. CVT Transmission	9
Audi	A6	2013-2018	2.0L Quattro. CVT Transmission	9
Audi	A6	2018-2023	2.0 40 TDI Mild Hybrid. 7-Speed AT	21
Audi	A7	2010-2018	1.4L, 2.0L; 2.8 TDI, 3.0 TDI. 7-Speed AT	21
Audi	A7	2012-2018	3.0L Quattro. CVT Transmission	9
Audi	A7	2017-2018	2.0L Quattro. CVT Transmission	9

Make	Model	Year	Type	No.
Audi	A7	2017-2023	3.0 TDI Mild Hybrid quattro. 7-Speed AT	21
Audi	A8	1997-1999	3.7L. 6-speed AT	12
Audi	A8	1997-2010	Quattro 4.2L. 6-speed AT	12
Audi	A8	2004-2012	4.2L Quattro. CVT Transmission	9
Audi	A8	2005-2010	6.0L Quattro. CVT Transmission	9
Audi	A8	2012-2018	3.0L Quattro. CVT Transmission	9
Audi	A8	2012-2018	6.3L Quattro. CVT Transmission	9
Audi	A8	2013-2018	4.0L Quattro. CVT Transmission	9
Audi	Q2	2016-2023	35 TDI quattro, SQ2 TFSI quattro	8
Audi	Q3	2015-2018	2.0L Q3 Quattro. 6-speed AT	3
Audi	Q3	2015-2020	2.0L. 6-speed AT	3
Audi	Q3	2015-2023	2.0L Quattro. 6-speed dual clutch	8
Audi	Q3	2016-2023	1.4L, 2.0L. 6-speed dual clutch	8
Audi	Q5	2008-2017	2.0L; 2.0 TDI. 7-Speed AT	21
Audi	Q5	2016-2023	2.0L quattro. 7-Speed AT	21
Audi	Q7	2007-2010	3.6L. 6-speed AT	3
Audi	R8 Spvder	2015-2023	4.2L, 5.2L. 6-speed dual clutch	8
Audi	RS3	2017-2020	2.5L. 6-speed dual clutch	8
Audi	RS4	2007-2008	4.2L. CVT Transmission	9
Audi	RS7	2014-2018	4.0L. CVT Transmission	9
Audi	TT	2003-2006	1.8L. 6-speed AT	3
Audi	TT	2004-2009	3.2L Quattro. 6-speed dual clutch	8
Audi	TT	2007-2016	2.0L. 6-speed dual clutch	8
Audi	TT	2009-2023	2.0L Quattro. 6-speed dual clutch	8
Audi	TT	2016-2018	1.8L. 6-speed dual clutch	8
Cadillac	ATS	2013-2015	2.0L, 2.5L, 3.6L	19
Cadillac	CTS	2009-2015	3.0L, 6.2L	19
Cadillac	CTS	2013-2015	2.0L, 3.6L	19
Cadillac	SRX	2007-2009	3.6L, 4.6L	19
Cadillac	STS	2006-2011	3.6L, 4.4L, 4.6L	19
Cadillac	XLR	2006-2009	4.4L, 4.6L	19
Chevrolet	Camaro	2010-2015	3.6L, 6.2L	19
Chevrolet	Caprice	2011-2017	3.6L, 6.0L	19
Chevrolet	Colorado	2015-2016	3.6L	19
Chevrolet	Colorado	2015-2022	2.5L, 2.8L	19
Chevrolet	Corvette	2006-2007	6.0L	19
Chevrolet	Corvette	2006-2013	7.0L	19
Chevrolet	Corvette	2008-2014	6.2L	19
Chevrolet	Silverado 1500	2019-2021	4.3L, 5.3L	19
Chevrolet	Silverado 2500	2020-2021	6.6L 2500 HD	19
Chevrolet	Silverado 3500	2020-2021	6.6L 3500 HD	19
Chevrolet	SS	2014-2017	6.2L	19
Chevrolet	Suburban 3500	2017-2019	6.0L 3500 HD	19
Ford	Explorer	2004-2010	4.0L 5R55S/W 5-speed A/T	1
Ford	Explorer Sport	2007-2010	4.0L, 4.6L 5R55S/W 5-speed A/T	1
Ford	Mustang	2005-2010	4.0L, 4.6L, 5.4L 5R55S/W 5-speed A/T	1
Ford	Thunderbird	2003-2005	3.9L 5R55S/W 5-speed A/T	1
GMC	Canvon	2015-2016	3.6L	19
GMC	Canvon	2015-2020	2.5L	19
GMC	Canvon	2016-2022	2.8L	19
GMC	Sierra 1500	2019-2020	4.3L, 5.3L	19
GMC	Sierra 2500 HD	2020-2020	6.6L 2500 HD	19
Infiniti	EX35	2011-2012	3.5L	13
Infiniti	EX37	2013-2013	3.7L	13
Infiniti	FX35	2009-2012	3.5L	13
Infiniti	FX37	2013-2013	3.7L	13
Infiniti	FX50	2009-2013	5.0L	13
Infiniti	G25	2011-2012	2.5L	13
Infiniti	G37	2009-2013	3.7L	13
Infiniti	M35	2009-2010	3.5L	13
Infiniti	M35h	2012-2013	3.5L	13
Infiniti	M37	2011-2013	3.7L	13
Infiniti	M45	2009-2010	4.5L	13
Infiniti	M56	2011-2013	5.6L	13
Infiniti	Q40	2015-2015	3.7L	13
Infiniti	Q50	2014-2021	3.5L, 3.7L	13
Infiniti	Q50	2016-2021	2.0L, 3.0L	13
Infiniti	Q60	2014-2015	3.7L	13
Infiniti	Q60	2017-2023	2.0L, 3.0L	13
Infiniti	Q70	2014-2018	3.5L, 5.6L	13
Infiniti	Q70	2016-2019	3.7L	13
Infiniti	Q70L	2015-2019	3.5L, 5.6L	13
Infiniti	QX50	2014-2017	3.7L	13
Infiniti	QX56	2011-2013	5.6L	13
Infiniti	QX70	2014-2017	3.7L, 5.0L	13
Infiniti	QX80	2014-2021	5.6L	13
Lincoln	Aviator	2004-2005	4.6L 5R55S/W 5-speed A/T	1
Lincoln	LS	2003-2006	3.9L 5R55S/W 5-speed A/T	1
Mercedes-Benz	C-Class A205	2016-2023	AMG C 43, 63, C 180; C 200, 220, 300 D	20
Mercedes-Benz	C-Class C204	2011-2023	C 180, 250, 350, 63 AMG; C 220, 250 CDI	10
Mercedes-Benz	C-Class C205	2015-2022	C 180, 300, 400; C 220, 300 D	20
Mercedes-Benz	C-Class CL203	2005-2008	C 230, C 350	10
Mercedes-Benz	C-Class W203	2005-2007	C 230, 280, 350; C 320 CDI	10
Mercedes-Benz	C-Class W204	2007-2013	C 180, 200, 230, 280, 350; C 320, 350 CDI	10
Mercedes-Benz	C-Class W205	2013-2022	C 160, 180; C 200, 300 D, C 300 EQ Boost 9G tronic	20

Make	Model	Year	Type	No.
Mercedes-Benz	C-Class W205	2014-2023	C 180, 200, 250, 400; C 180, 220, 250 BlueTEC/d 7-speed A/T	10
Mercedes-Benz	CLC-Class CL203	2008-2011	CLC 230, CLC 350	10
Mercedes-Benz	CLK A209	2003-2010	CLK 280, 350, 500; CLK 320 CDI	10
Mercedes-Benz	CLK C209	2002-2009	55 AMG, 280, 350, 500	10
Mercedes-Benz	CLS C218	2011-2017	CLS 350, 400, 500; CLS 220, 250, 350 CDI 7-speed A/T	10
Mercedes-Benz	CLS C218	2011-2017	CLS 350; CLS 220, 250, 350 BlueTec/d 9G tronic	20
Mercedes-Benz	CLS C219	2004-2010	CLS 63 AMG, 350, 500; CLS 320 CDI	10
Mercedes-Benz	CLS C257	2017-2022	CLS 220, 300, 350, 400 D	20
Mercedes-Benz	CLS X218	2012-2017	CLS 350, 400, 500; CLS 220, 250 CDI / BlueTEC / d	10
Mercedes-Benz	E-Class A207	2010-2016	E 220, 350 BlueTEC, E 350 BlueTec/d	20
Mercedes-Benz	E-Class C207	2009-2016	E 220, 350 BlueTEC, E 350 BlueTec/d	20
Mercedes-Benz	E-Class C238	2016-2022	AMG E 53 EQ Boost 4-matic+, E 300 EQ Boost	20
Mercedes-Benz	E-Class W211	2002-2008	E 230, 280, 350, 500; E 280, 320, 420 CDI	10
Mercedes-Benz	E-Class W212	2009-2016	E 200 CDI / BlueTEC	10
Mercedes-Benz	E-Class W212	2009-2016	E 220, 350 BlueTEC, E 350 BlueTec/d	20
Mercedes-Benz	E-Class W213	2016-2022	E 200, 300, 400 4matic; E 220 D	20
Mercedes-Benz	G-Class W463	1998-2023	G 65 AMG, G 500; G 350 CDI	10
Mercedes-Benz	GLC C253	2016-2020	AMG 63 4matic+; 200, 220, 300 D; 200 EQ Boost	20
Mercedes-Benz	GLC X253	2015-2023	AMG 63 4matic+; 200, 220, 300 D; 200 EQ Boost	20
Mercedes-Benz	GL-Class X164	2006-2020	GL 450 4-matic; GL 350, 420 CDI 4-matic	10
Mercedes-Benz	GL-Class X166	2012-2015	GL 63 AMG, 500 4-matic; GL 350 CDI / BlueTec	10
Mercedes-Benz	GLE C292	2015-2019	400, 500 4matic; 350 D 4matic	20
Mercedes-Benz	GLE W166	2015-2018	320, 400, 500 4matic; 250, 350 D	20
Mercedes-Benz	GLE W167	2018-2023	GLE 300, 350, 400 D 4matic	20
Mercedes-Benz	GLK-Class X204	2008-2015	280, 300, 350 4-matic; 220, 250, 350 CDI	10
Mercedes-Benz	GLS X166	2015-2019	400, 500 4matic, AMG 63 4matic; 350, 400 D	20
Mercedes-Benz	GLS X167	2019-2023	400, 500, AMG 63 4matic; 350, 400 D 4matic	20
Mercedes-Benz	M-Class W164	2005-2011	ML 350, 500 4-matic; ML 320, 420 CDI 4-matic	10
Mercedes-Benz	M-Class W166	2011-2015	ML 63 AMG, 400, 500 4-matic; ML 350 BlueTEC	10
Mercedes-Benz	R-Class W251	2006-2020	R 280, 300, 350, 500; R 280, 320 CDI 4-matic	10
Mercedes-Benz	S-Class A217	2015-2022	S 560, S 650 Maybach	20
Mercedes-Benz	S-Class C216	2006-2013	CL 65 AMG, CL 500	10
Mercedes-Benz	S-Class C217	2014-2017	S 63 AMG 4-matic, S 500 4-matic	10
Mercedes-Benz	S-Class C217	2014-2022	S 400, 450, 560 4matic	20
Mercedes-Benz	S-Class W220	1998-2005	S 500	10
Mercedes-Benz	S-Class W221	2005-2013	S 280 350, 450, 500; S 320, 420 CDI	10
Mercedes-Benz	S-Class W222	2013-2023	S 320, 400, 560, 600; S 350, 400 D 9G tronic	20
Mercedes-Benz	S-Class W222	2013-2023	S 63 AMG, 500 4-matic, 600; S 350 BlueTEC / d 7-speed A/T	10
Mercedes-Benz	SL R230	2001-2012	65 AMG, 350, 400, 500	10
Mercedes-Benz	SL R231	2012-2022	400, 500 9G tronic	20
Mercedes-Benz	SL R231	2012-2023	65 AMG, 350, 400, 500	10
Mercedes-Benz	SLC R172	2016-2023	180, 200, 300, AMG SLC 43	20
Mercedes-Benz	SLK R171	2004-2011	55 AMG, 280, 300, 350	10
Mercedes-Benz	SLK R172	2011-2023	200, 300; 250 CDI/d 9G tronic	20
Mercedes-Benz	SLK R172	2011-2023	55 AMG, 200, 250, 350; 250 CDI / d 7-speed A/T	10
Mercedes-Benz	Sprinter 3.5-t	2006-2023	314 CDi, 316 CDi	20
Mercedes-Benz	Sprinter 3-t	2006-2023	211 CDi, 214 CDi	20
Mercedes-Benz	Sprinter 4-t	1995-2023	411 CDi, 414 CDi, 416 CDi, 419 CDi	20
Mercedes-Benz	Sprinter 5-t	2006-2023	511 CDi, 514 CDi, 516 CDi, 519 CDi	20
Mercedes-Benz	V-Class W447	2014-2020	V 200, 220, 250 CDI / d 7-speed A/T	10
Mercedes-Benz	V-Class W447	2014-2023	V 250; V 220, 250, 300 CDI/d 9G tronic	20
Mercedes-Benz	Vito W447	2014-2020	114 116, 119 CDI 7-speed A/T	10
Mercedes-Benz	Vito W447	2014-2022	109 CDi, 111 CDi, 114 CDi, 116 CDi; eVito 9G tronic	20
Mercurv	Mountaineer	2004-2010	4.0L 5R55S/W 5-speed A/T	1
Mini	Cooper	2000-2006	R50	17
Mini	Cooper	2002-2008	R51	17
Mini	One 1.6i	2000-2006	R50	17
Nissan	370Z	2009-2020	3.7L	13
Nissan	Altima	2007-2023	2.0L, 2.5L, 3.5L	16
Nissan	Armada	2017-2023	5.6L	13
Nissan	Cube	2009-2014	1.8L	16
Nissan	Juke	2014-2017	1.6L	16
Nissan	Kicks	2018-2023	1.6L	16
Nissan	Maxima	2006-2014	3.5L	16
Nissan	Maxima	2007-2023	3.5L, except 2015	16
Nissan	Murano	2003-2023	2.5L, 3.5L, except 2008	16
Nissan	NV1500	2019-2021	4.0L	13
Nissan	NV200	2015-2021	2.0L	16
Nissan	NV2500	2019-2021	5.6L	13
Nissan	NV3500	2019-2021	4.0L, 5.6L	13
Nissan	Pathfinder	2013-2020	3.5L	16
Nissan	Quest	2011-2017	3.5L	16
Nissan	Rogue	2008-2010	2.0L, 2.5L	16
Nissan	Rogue	2014-2023	2.0L, 2.5L	16
Nissan	Rogue Sport	2017-2023	2.0L	16
Nissan	Sentra	2013-2023	1.6L, 1.8L, 2.0L	16
Nissan	Serena	2012-2018	S-hybrid	18
Nissan	Titan	2017-2022	5.6L	13
Nissan	Titan XD	2017-2021	5.6L	13
Nissan	Versa	2007-2023	1.6L, 1.8L	16
Nissan	Versa Note	2014-2019	1.6L	16
Pontiac	G8	2008-2009	3.6L	19
Porsche	996 Carrera	1999-2001	--	12
Porsche	Boxster	1997-2008	--	12
Porsche	Cayman	2006-2008	--	12

Make	Model	Year	Type	No.
Porsche	Macan	2015-2023	3.0L, 3.6L CVT Transmission	9
Seat	Cordoba	2002-2009	1.2, 1.4, 1.6, 2.0L; 1.4 TDI, 1.9 TDI	11
Skoda	Octavia	2005-2010	2.0L. CVT Transmission	9
Toyota	4Runner	2003-2022	4.0L, 4.7L	7
Toyota	FJ Cruiser	2007-2014	4.0L	7
Toyota	Land Cruiser	2003-2022	4.7L, 5.7L	7
Toyota	Sequoia	2004-2022	4.6L, 4.7L, 5.7L	7
Toyota	Tacoma	2005-2022	2.7L, 3.5L, 4.0L	7
Toyota	Tundra	2004-2022	4.0L, 4.6L, 4.7L, 5.7L	7
Volvo	S60	2006-2016	2.5L	2
Volvo	S60	2011-2016	3.0L	2
Volvo	S60	2014-2023	2.0L	2
Volvo	S60	2016-2018	2.0L, 2.5L Cross Country	2
Volvo	S80	2007-2010	4.4L	2
Volvo	S80	2007-2015	3.0, 3.2L	2
Volvo	S80	2014-2016	2.0L	2
Volvo	S90	2017-2023	2.0L	2
Volvo	V60	2014-2016	2.5L, 3.0L	2
Volvo	V60	2014-2023	2.0L	2
Volvo	V60	2015-2016	2.5L Cross Country	2
Volvo	V60	2017-2022	2.0L Cross Country	2
Volvo	V70	2006-2007	2.5L	2
Volvo	V70	2008-2010	3.0L, 3.2L	2
Volvo	V90	2017-2021	2.0L, 2.0L Cross Country	2
Volvo	XC40	2018-2022	2.0L	2
Volvo	XC60	2009-2016	3.0L, 3.2L	2
Volvo	XC60	2014-2023	2.0L	2
Volvo	XC60	2015-2016	2.5L	2
Volvo	XC70	2008-2015	3.0L, 3.2L	2
Volvo	XC70	2014-2016	2.0L, 2.5L	2
Volvo	XC90	2005-2011	4.4L	2
Volvo	XC90	2007-2014	3.2L	2
Volvo	XC90	2016-2019	2.0L	2
VW	Arteon	2017-2019	7-speed dual clutch	8
VW	Arteon	2019-2021	2.0L. 6-speed AT	3
VW	Atlas	2018-2023	2.0L. 6-speed AT	3
VW	Atlas Cross Sport	2020-2023	2.0L. 6-speed AT	3
VW	Atlas Cross Sport	2020-2023	3.6L. 6-speed AT	3
VW	Beetle	2002-2006	1.8, 1.9L. 6-speed AT	3
VW	Beetle	2002-2006	1.9L. 6-speed dual clutch	8
VW	Beetle	2002-2019	2.0L. 6-speed AT	3
VW	Beetle	2006-2019	2.5L. 6-speed AT	3
VW	Beetle	2012-2019	2.0L. 6-speed dual clutch	8
VW	Beetle	2014-2017	1.8L. 6-speed AT	3
VW	CC	2009-2017	2.0L, 3.6L. 6-speed AT	3
VW	CC	2012-2017	2.0L, 3.6L. 6-speed dual clutch	8
VW	EOS	2006-2015	1.4, 1.6, 2.0, 3.2L; 2.0 TDI	11
VW	EOS	2007-2016	2.0L, 3.2L. 6-speed dual clutch	8
VW	Golf	2006-2007	1.9L, 2.0L. 6-speed AT	3
VW	Golf	2006-2015	2.0L. 6-speed dual clutch	8
VW	Golf	2006-2017	2.0L GTI. 6-speed AT	3
VW	Golf	2006-2023	2.0L Golf GTI. 6-speed dual clutch	8
VW	Golf	2010-2011	2.5L. 6-speed dual clutch	8
VW	Golf	2010-2015	2.0L, 2.5L. 6-speed AT	3
VW	Golf	2015-2017	1.4, 1.8L. 6-speed AT	3
VW	Golf	2017-2019	1.8L Alltrack. 6-speed dual clutch	8
VW	Golf	2018-2023	1.4L, 1.8L. 6-speed dual clutch	8
VW	Jetta	2005-2010	1.9L. 6-speed dual clutch	8
VW	Jetta	2005-2023	2.0L. 6-speed dual clutch	8
VW	Jetta	2014-2018	1.4, 1.8L. 6-speed AT	3
VW	Jetta	2019-2023	1.4L. 6-speed dual clutch	8
VW	Passat	1998-2005	1.8L, 2.8L. 6-speed AT	12
VW	Passat	2002-2004	4.0L. 6-speed AT	12
VW	Passat	2004-2006	2.0L, 4.2L. 6-speed AT	12
VW	Passat	2006-2010	2.0L. 6-speed AT	14
VW	Passat	2006-2010	3.6L. 6-speed AT	14
VW	Passat	2009-2012	2.0L Passat CC. 6-speed dual clutch	8
VW	Passat	2009-2018	3.6L. 6-speed dual clutch	8
VW	Passat	2009-2023	2.0L. 6-speed dual clutch	8
VW	Passat	2014-2017	1.8L. 6-speed AT	14
VW	Passat	2018-2022	2.0L. 6-speed AT	14
VW	Phaeton	2004-2006	6.0L. 6-speed AT	12
VW	Rabbit	2008-2009	2.5L. 6-speed dual clutch	8
VW	Sharan	2010-2023	1.4 TSI, 2.0 TDI 4motion	8
VW	Tiquan	2009-2022	2.0L. 6-speed AT	14
VW	Tiquan	2012-2023	2.0L. 6-speed dual clutch	8
VW	Tiquan	2013-2023	1.4L. 6-speed AT	14
VW	Tiquan	2013-2023	1.4L. 6-speed dual clutch	8
VW	Touareg	2002-2006	3.2 V6	11
VW	Touareg	2002-2010	4.2 V8; 5.0 TDI	11
VW	Touareg	2004-2010	6.0 W12; 2.5 R5 TDI, 3.0 TDI	11
VW	Touareg	2005-2018	3.6 V6 FSI	11
VW	Touareg	2010-2018	3.0 V6 TDI, 4.2 V8 FSI; 3.0 TDI Hybrid	11
VW	Touran	2003-2023	2.0 TDI	8
VW	T-Roc	2018-2019	6-speed manual transmission	9
VW	T-Roc	2018-2019	7-speed dual clutch gearbox for 4x4	8